

FIBRA DE VIDRIO ESCALERA MULTIUSOS

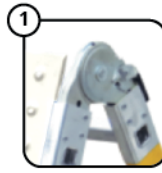

Articulaciones de acero

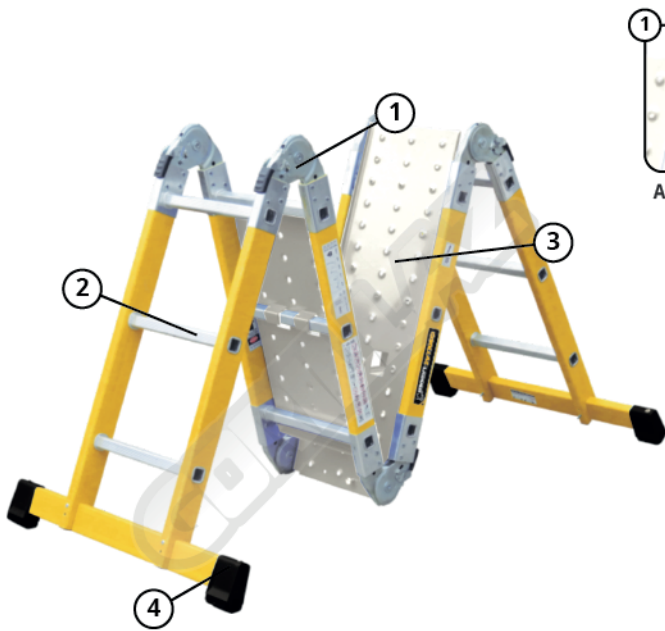
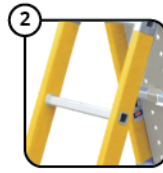

Peldaños antideslizantes

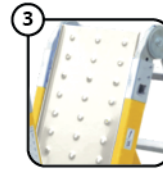

Plataforma de acero

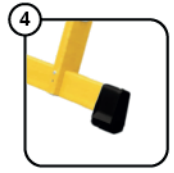

Zapatas antideslizantes

TIPO ANDAMIO

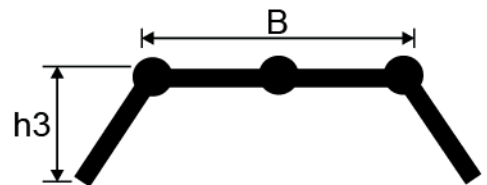

CERRADO

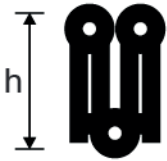

TIPO TIJERA

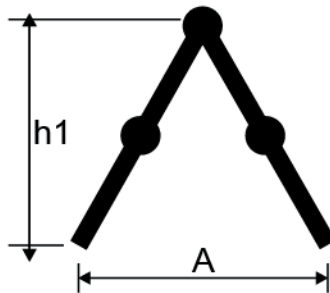

TIPO ARRIMO

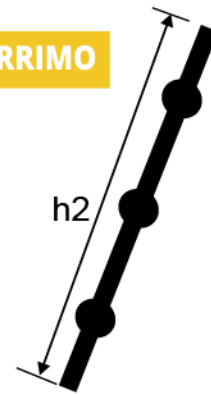

TIPO IA - 150Kg./330Lbs

DIMENSIONES (m)

| Modelo | Pasos | Cap. | Frecuencia de Trabajo | PESO KG | h | h1 | A | h2 | h3 | B |
|------------|-------|-------|-----------------------|---------|------|------|------|------|------|------|
| GFM-12IA+P | 12 | 150kg | Alta | 19.50 | 0.99 | 1.75 | 1.12 | 3.54 | 0.94 | 1.96 |